



oasis  
aquatics



Automatic Chemical Dosing System

# Oasis SmartChem

INSTALLATION AND OPERATION MANUAL



Head Office  
6-8 Austral Place  
Hallam VIC 3803  
T: 03 9887 2131

New South Wales  
Unit 2, 10 Boden Road  
Seven Hills NSW 2147  
T: 02 9838 0000

Queensland  
11 Andy Court  
Upper Coomera QLD 4209  
T: 07 5679 6821



[sunloverheating.com.au](http://sunloverheating.com.au)  
[sales@sunloverheating.com.au](mailto:sales@sunloverheating.com.au)



# TABLE OF CONTENTS

1. IMPORTANT WARNINGS & SAFETY INSTRUCTIONS .....	2
2. GENERAL OVERVIEW .....	3
3. INSTALLATION.....	4
Mounting.....	4
Installation Diagram .....	4
Base Plate .....	6
Controller Connection .....	8
App Setup.....	9
4. ANCILLARY INSTRUCTIONS.....	13
Maintenance Schedule .....	13
Probe Cleaning.....	14
Replacing The Squeeze Tube .....	15
5. SYSTEM TROUBLESHOOTING.....	16
6. FURTHER INFORMATION .....	19
7. WARRANTY .....	21
8. TECHNICAL SUPPORT.....	22
9. NOTES .....	23

# 1. IMPORTANT WARNINGS & SAFETY INSTRUCTIONS

## IMPORTANT WARNINGS



This manual contains important information about the installation, operation and safe use of this product. This information should be given to the owner and/or operator of this equipment.

When installing and using this electrical equipment, basic safety precautions should always be followed. Failure to follow safety warnings and instructions in this manual can result in serious injury and/or damage to your equipment. Read and follow all warning notices and instructions which are included in this manual.

The Power Supply internally contains live components. There is a danger of electric shock if opened. If the power cord is damaged then it should be replaced by the manufacturer, their agent or similar.



To reduce the risk of injury, **DO NOT** permit young children to use this product unless they have been trained by the person responsible for their safety and they acknowledge their ability to use such equipment. To reduce the risk of accidents or incidents, service on the unit should only be performed by your local pool Professional.

Ideally, as with all pool equipment, the controller should be installed out of direct weather. The service life of the **Oasis SmartChem** will be longer if it is not exposed to direct sunlight and rain.

Before installing, and turning on the **Oasis SmartChem** system, take a sample of your Pool/Spa water to a pool store and have it tested to ensure that the Pool/Spa system is properly balanced. See below for recommended pool chemical ranges;

CHLORINE: 1 - 3ppm

pH 7.2 - 7.8

TOTAL ALKALINITY: 80 - 150 mg/L

CALCIUM HARDNESS: 90 - 300 mg/L

PHOSPHATE FREE: (0)

TOTAL DISSOLVED SOLIDS: Below 1500ppm

**Always take a sample of your pool water away from the return jets to ensure as accurate reading as possible.**

Always store Pool Chemicals in a well-ventilated position, at least 1.8M away from your pool equipment to prevent fume build-up and causing corrosion of your pool equipment.



When mixing acid with water, ALWAYS ADD ACID TO WATER. NEVER ADD WATER TO ACID. If you add water to acid, it will violently react (creating heat and boiling) and you may be splashed with acid. Wear protective equipment such as Gloves and Face Shield when diluting the acid.

Only use diluted Acid, never use concentrated Acid. ACID should be diluted with water within the range of 1 part Acid to 1 part Water (1:1) to 1 part Acid to 2 parts Water (1:2). Dilute the acid in a well ventilate area and have running water ready. In case of spillage, wash down area immediately. Always seek medical advice if breathing is affected or an Acid Burn occurs.

**NEVER MIX CHEMICALS.** Store your pool chemicals in containers that are visibly different by either colour and or size. Poisonous Gas can be produced if you mix chemicals. Always store chemicals in accordance to the relevant Dangerous Goods Codes and Standards.

It is highly recommended that you check your Water Chemistry (especially the pH and Chlorine levels) regularly, either with a quality test kit or at your local pool store to ensure that the **Oasis SmartChem** is working correctly, to ensure there are no malfunctions, and to ensure that the pH and ORP sensors are reading correctly.

It is highly recommended that before you install the **Oasis SmartChem** system, that you sit the probe/s in your pool water for 24hrs. This will help the probes to give a more accurate reading from the time of installation and will help with the longevity of the probes.

## 2. GENERAL OVERVIEW



Congratulations on your recent purchase of your **Oasis Aquatics SmartChem** system.

Please take a moment to read through the entire manual before installing your new unit. Your **Oasis SmartChem** system must be installed and operated as specified.

While every effort has been made to ensure that the information contained in this guide is accurate and complete, no liability can be accepted for any errors or omissions. **Oasis Aquatics Pty Ltd** reserves the right to change the specification of the hardware and software described herein at any time without prior notice.

Thank you again for choosing an Oasis Aquatics Smartchem system. We wish you many happy years of swimming in your crystal clear pool.

### INTRODUCTION

The **Oasis SmartChem** is designed to monitor and automatically adjust the **pH** and Chlorine (**ORP**) levels of all types of Pools & Spas while the filtration pump is running.

Once the **pH** and **ORP** levels have been set in the Oasis Smart App, the **Oasis SmartChem** will automatically dose Pool acid (when it is required) to maintain the set pH level. The **Oasis SmartChem** will also maintain the systems ORP by either turning the Chlorinator On or Off, or by automatically dosing Chlorine if you prefer Liquid Chlorine or are utilising an Ioniser.

The **pH** number is a measurement of how Acidic or Alkaline your Pool/Spa systems water is. As close the 7.0-7.8 is almost neutral so it's not harmful to swimmers. Too much acid (low pH) will cause the surface of the pool to degrade quicker.

The **ORP** is a measurement of Chlorine activity (Oxidising properties) in your Poo/Spa systems water and is measured in millivolts.

It has been ascertained that a Pool system with an ORP reading of 650Mv will eliminate E-coli type bacteria in about a second. The lower the ORP reading, the longer it will take for the bacteria to be eliminated from the system. An ORP reading of 550Mv will mean that it could take up to 2hrs for the bacteria to be eliminated.

### IMPORTANT

**THE OASIS SMARTCHEM IS NOT DESIGNED TO BRING THE POOL/SPA SYSTEM INTO BALANCE; IT IS DESIGNED TO MAINTAIN A BALANCED SYSTEM.**

Make sure your pool water is well balanced with the correct pH, Total Dissolved Solids (TDS), Calcium Hardness levels and is Phosphate free.

### 3. INSTALLATION

#### Mounting

**IDEALLY, AS WITH ALL POOL EQUIPMENT, THE CONTROLLER SHOULD BE INSTALLED OUT OF DIRECT WEATHER.**

- Find a suitable location to mount the control box.
- The controller should be mounted no closer than 3 metres from the water's edge, at a minimum of 600mm above the ground.
- Fix the mounting bracket to a solid structure with the screw and wall plug kit provided. Slide the controller on, locking it into place. Adjust the screws on the back of unit to ensure a snug fit.
- To remove unit, lift and gently pull away from structure.

#### PACKAGE CONTENTS:

- **Oasis SmartChem** controller (with a peristaltic pump attached).
- pH sensor (or pH + ORP depending on which kit is being fitted).
- Sensor Manifold (suits 50mm pipe, 2 reducing bushes required if installing into 40mm pipe) for the sensors to mount into (the centre of the inputs will be drilled out to accommodate the sensor probes).
- A power cable providing power to the **Oasis SmartChem** from a valve actuator port
- A communication cable to connect the **Oasis SmartChem** to either the Maser controller (if no Expansion Units are connected) or an Expansion Unit (if fitted).
- A check valve.
- An Injection Manifold (suits 50mm pipe, 2 reducing bushes required if installing into 40mm pipe) for the injection hose to be connected to.
- A bottle/tub connection kit (including lids, breather connection and bottle/tub tube).
- A 5M length of tubing.
- Blanking caps.

#### Installation Diagram

WARNING: **DO NOT** plug in if carton has been wet

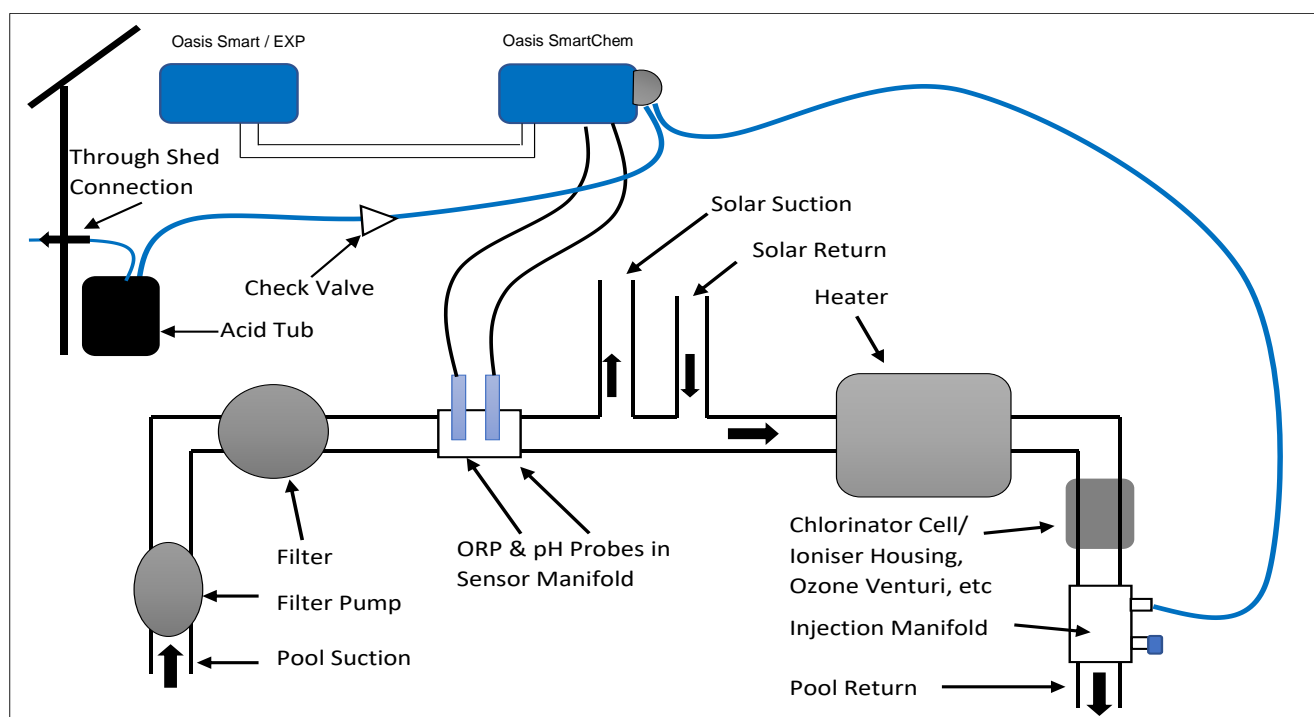

**DO NOT CONNECT POWER TO THE OASIS SMARTCHEM UNTIL ALL THE FOLLOWING CRITERIA HAS BEEN MET.**

- Take a sample of your pool water to a pool shop, have it tested and have balanced your pool to the appropriate ranges as specified on pg1.
  - Always take a sample of your pool water away from the return jets to ensure an accurate reading.
- It is highly recommended that before you install the **Oasis SmartChem** system, that you sit the probe/s in your pool water for 24hrs. This will help the probes to give a more accurate reading from the time of installation and will help with the longevity of the probes.

**DO NOT CUT ANY PIPEWORK TO FIT THE MANIFOLDS BEFORE TURNING ANY FILTRATION, CLEANING, CIRCULATION OR HEATING PUMPS OFF.**

**You will need to leave them off for a period of time to ensure the glue used to connect the manifolds has had the appropriate time to dry and bond properly to achieve correct pressure rating.**

The Sensor & Injection Manifolds suit 50mm pipe, 4 reducing bushes will be required if you are installing the manifolds into 40mm pipe.

- The pH and ORP probes and the appropriate Sensor Manifold have been installed into the pipework (see the diagram below).
  - The pH and ORP probes will be inserted into small bottles of solution. It is advised that you keep these bottles (after rinsing them out) for long term storage capability of the probes if necessary.

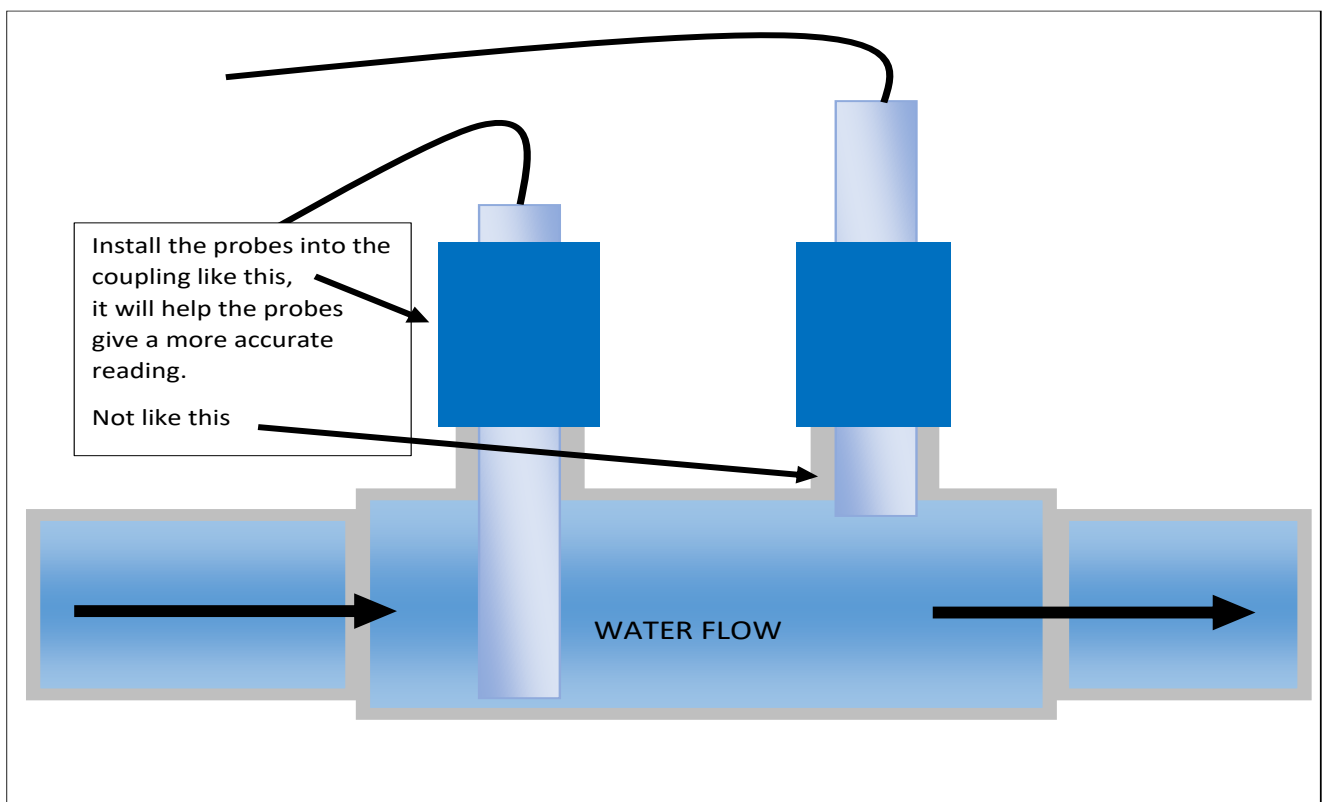

- The pH and ORP probes have been plugged into the **Oasis SmartChem** controller. (see diagram **below**)
- The communication cable from the **Oasis SmartChem** has been connected to either the Oasis Smart Master Controller or the right-hand port in the last Expansion Unit. (see diagram **below**)



- The Injection Manifold has been installed into the pipework.
  - Please ensure that a blanking cap is installed on the un-used injection port to prevent water leaking.
- The injection hose has been installed between the peristaltic pump and the Injection Manifold.
  - Allow a little extra tubing length in case the injection tubing needs to be trimmed at a later stage.

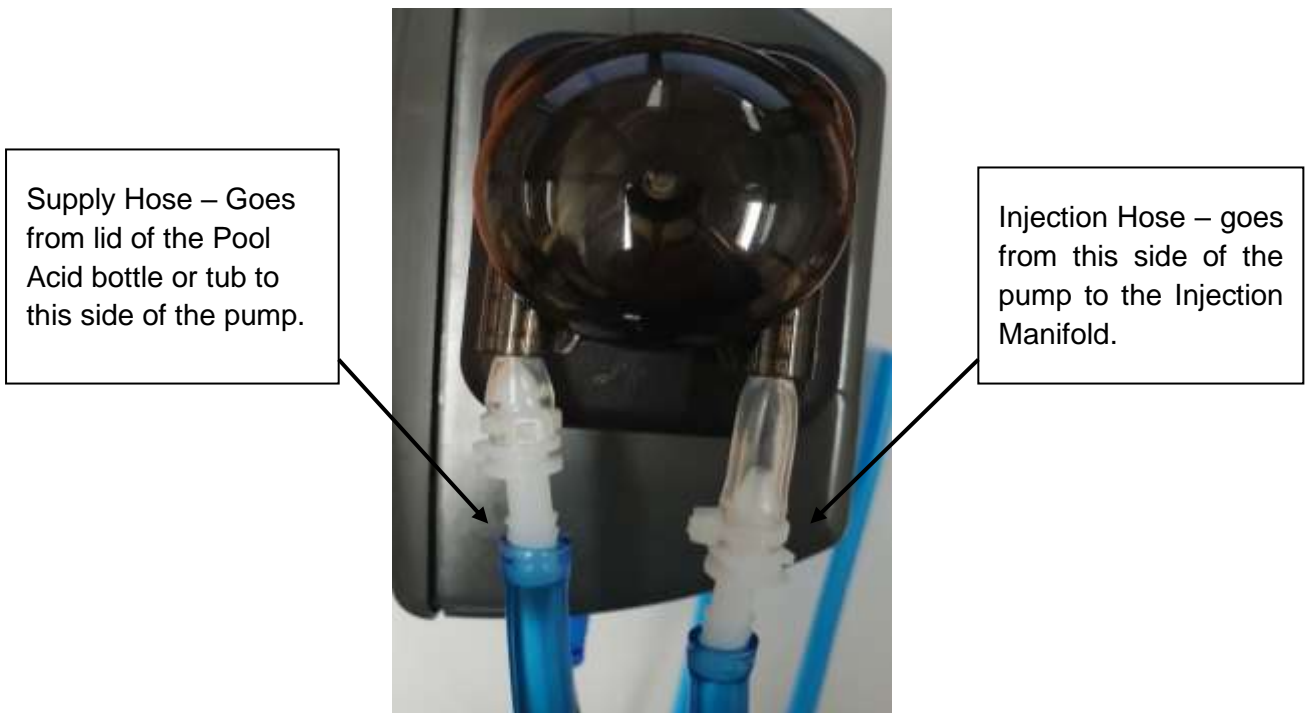

HINT: Soak the ends of supply and injection hoses in hot water for 30 seconds to soften them, this will make it easier when fitting the tubes to the pump barbs.

The lid kit has been installed into the bottle/tub of Pool Acid.

**IMPORTANT: Always store Pool Chemicals in a well-ventilated position in accordance to the relevant Dangerous Goods Codes and Standards, to prevent fume build-up, and at least 1.8M away from your pool equipment so as to not cause corrosion damage of your pool equipment.**

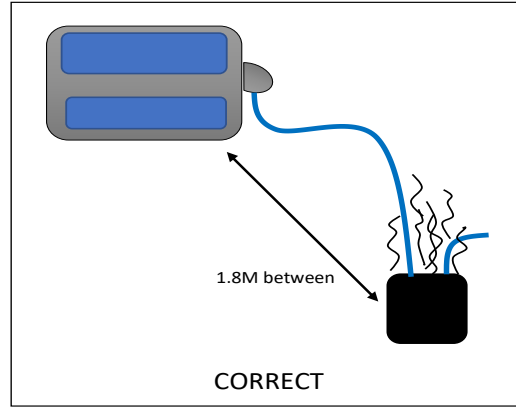
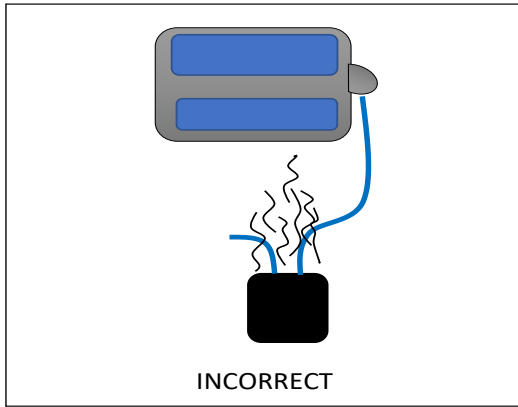

- The injection hose has been installed between the peristaltic pump and the bottle/tub of Pool Acid, with the Check Valve installed between the peristaltic pump and the lid of the Acid bottle/tub lid.
- Install some leftover injection hose to the breather port on the bottle/tub lid.

**IMPORTANT:** If the bottle/tub of Pool Acid is stored inside a shelter or shed, run some of the injection piping from the breather port on the lid, to outside of the shed or shelter.

A through shed connection is supplied to prevent a build-up of fumes inside the shed/shelter.

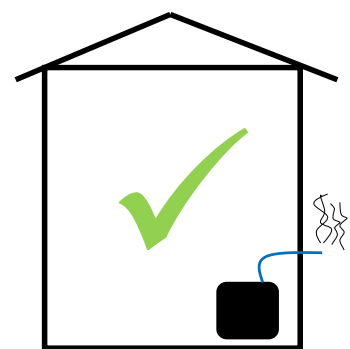
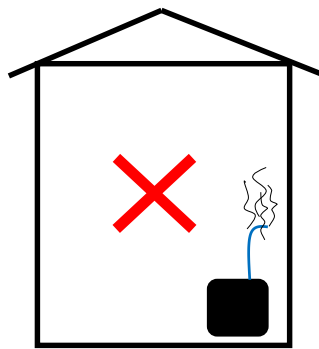

**ENSURE THAT THE OASIS SMART CONTROLLER IS RUNNING THE LATEST VERSION OF SOFTWARE.**

If not, complete any available Firmware Updates (see pg 9 of the Oasis Smart Quick Start Guide for instructions on how to complete).

- Lastly, connect the power cable from a valve actuator port (at the base of the Oasis Smart Master Controller) to the **Oasis SmartChem** (see Base Plate Diagram on page 5). As power is only been taken from the Valve Actuator output, the valve



## Controller Connection

1. On the Oasis Smart Master Controller, you will need to enter into the Expansion Unit portion of the menu. Do this by pressing the Menu button until you see 1. Filter Times appear, scroll down to 6. Installer setup and press Enter. You will see 6-1. Appliances, scroll down to 6-10 Expansion Units and press Enter.
2. Once you Enter into 6-10 Expansion Units, you will be pressing Enter to get through all the setting to do with the normal Expansion Units. The controller will display:
  - EXP:1        1.00B1        \*
  - EXP:2        NONE
  - Press Enter and the controller will then display:
  - NUMBER    EXP
  - UNITS    1
  - Press Enter and the controller will display:
  - RESET    ALL
  - ADDRESSES    NO
  - Ensure that NO is displayed and press Enter. The controller will display:
  - SCAN FOR EXP
  - UNITS NOW?    NO
  - Ensure that NO is displayed and press Enter. The controller will then display:
  - SMARTCHEM
  - V1.00B07        (If already received, otherwise this line will be blank)
3. If the version number is already displayed then the **Oasis SmartChem** is now active to be utilised through the App (go to page 7 Of this guide) and you can exit the menu by pressing the Menu button, or if you need to reset the **Oasis SmartChem** unit press Enter and see below for further instructions.
4. If the lower line was blank, press Enter and the controller will display:
  - RESET
  - SMARTCHEM                    NO
5. If you would like to Reset the **Oasis SmartChem** or install another unit, use the ↑ or ↓ buttons to change from NO to YES and press Enter. The controller will then display that the “Reset Done”, press Enter to move to the next function.
6. If you are setting up the **Oasis SmartChem** for the first time, make sure the controller has NO displayed and press Enter. The controller will display:
  - SCAN SMARTCHEM
  - NOW                    NO
7. If you don't want to scan for an **Oasis SmartChem** , make sure the controller is displaying NO and press Enter and the controller will exit you to the Installer Menu.
8. If you have Reset the **Oasis SmartChem** or are setting it up for the first time you will use the ↑ or ↓ buttons to change from NO to YES and press Enter. After a few seconds of searching, the controller will then display:
  - SMARTCHEM
  - V1.00B07

Once it does, the **Oasis SmartChem** is now active and can be utilised through the App and you can exit the Expansion menu by pressing the Menu button on the controller.

## App Setup

If you not already completed the latest Firmware Update through the Oasis Smart App, do so now to be able to continue further with the Chemical Setup. See pg 9 of the Oasis Smart Quick Start Guide for instructions on how to complete the Firmware Update.

### Updated App Menu

When you have updated the Firmware of your Oasis Smart system and completed the Controller Connection, you will see 2 new options in the App menu.

The first one is Chemical Balance.

The second new option is Chemical Setup. You will not be able to set either your pH level or your ORP level without first going into the Chemical Setup menu option first.



### Chemical Setup

When you go into the Chemical Setup option in the menu you will see this display.

The first thing that you will need to do, is tell the **Oasis SmartChem** system what sizes your pool and spa are.

Simply tap on the figure beside Pool Size and then scroll either up or down to the figure that best represents the size of your pool, and press OK.

**Note:** If the size of your pool is in-between 2 pool sizes, select the size that is closet.

For example; choose the Pool Size of 55,000L if your actual pool size is 53,500L.

Do the same for your Spa.

**Note:** If you don't have a spa, then the option to choose the Spa size won't be displayed.

Once you have set your Pool size (and Spa size if you have one), tap on the red buttons beside pH Sensor and ORP Sensor (will turn Green) to activate them.



## Chemical Setup (continued)

After you have activated both the pH and ORP Sensors the **Oasis SmartChem** will display this.

- You will be able to adjust the pH Offset. The Offset allows you to adjust the reading of the probe. Your probe may be reading pH at 7.7, but after proper testing of your pool water the actual reading may be 7.6. You would then adjust the Offset to -0.1.
- The reading in brackets below the Offset is your current pH reading.
- The pH Set Point is the level of pH that you would like your Pool/Spa system to be running at. You can either tap along the line anywhere or tap and drag to adjust the Set Point to where you would like it to be.
- You will also need to tap the button beside Acid Dosing to activate/deactivate the Acid Dosing Pump attached to the side of the **Oasis SmartChem** controller.
- The Acid Dosing button will generally be left On. The only time you might turn it off would be if there is a problem with the pump, you are changing over the acid bottle/tub or if you have run out of Acid.

### The same functionality applies to the ORP Sensor.

- The Offset will allow you to adjust the reading of the probe either higher or lower. This will in turn effect when chlorination is called for, either delaying chlorination or increasing its frequency.
- The reading in the brackets is your current ORP reading.
- You will tap and or slide the Set Point to set what Level of ORP you would like your system to run too.
- When the Probe Settle Time is turned on, no dosing is done for the first 30 minutes after the circulation pump is turned on. If it is turned Off, dosing will commence as soon as the pump starts.

### Notes:

- Acid is only dosed when the pH reading is higher than the pH Set Point. If the pH reading is above 8.5 then acid will not be dosed. You will need to manually add acid.
- The pH Offset will only allow adjustment of up +1.5 or -1.5 points.
- Chlorine is added/dosed only when the ORP reading is below the ORP Set Point. If the reading is below 300mV then Chlorine won't be dosed, and you will need to manually add chlorine.
- The ORP Offset will only allow an adjustment of +150mV to -150mV.



## Chemical Balance

The other new menu option is Chemical Balance. (See the App Menu on page 7)

- In this menu option you will be able to adjust your set levels for both pH and ORP. Both of these levels can be adjusted by either dragging the set point or by tapping along the Set Point line.
- Underneath the Set Point line will be displayed what the Acid Pump is doing. For instance (as displayed to the right); the Acid pump is in its waiting cycle after dosing, to take a future reading to see if it needs to dose again. It is also displaying the last time that it dosed.
- The Prime button allows you to cycle the Acid Dosing pump for 10 seconds to get the pump primed and to ensure that it is working. After you press the priming button, it will give you a 10 second count to let you know how much time is left for the priming cycle.



The following is displayed on the App Home Screen.

There is only a limited amount of information displayed in regards to the Chemical Balance information.

It displays whether the pH is Low, Normal or High.

The ORP will also display whether it is Low, Normal or High.

On the right-hand side of the box there is a plus (+) symbol that when tapped, will allow the Chemical balance window to be expanded.



Once the Chemical Balance display window is expanded, the window displays the following.

With the pH highlighted, the Chemical Balance window will display;

1. Whether the pH is Low, Normal, or High.
2. What the actual pH level is currently.
3. What the Set Point for pH is set to achieve.

### NOTES:

- A low pH reading indicates that the pool water has become Acidic. This can lead to skin and eyes being irritated during swimming.
- A high pH reading indicates that the pool water has become Alkaline. This makes it harder for the Chlorine to kill the germs in the pool water.



## Chemical Balance (continued)

When ORP is highlighted, the Chemical Balance window will display;

1. Whether the ORP is Low, Normal, or High.
2. What the actual ORP level is currently.
3. What the Set Point for ORP is set to achieve.

### NOTES:

- A low ORP reading indicates that the pool water may be carrying live and potentially dangerous germs that could make swimmers ill.
- A high ORP reading could lead to swimwear being bleached and could also irritate the skin and eyes of swimmers.



## Diagnostics

If your Pool/Spa systems water is not balanced correctly, you may see the following on the home screen of the App.

What the **Oasis SmartChem** is displaying is the following;

1. The pH reading is outside of the systems reading range of 5.5 to 8.5. If the reading is lower than 5.5 (<5.5) or higher than 8.5 (>8.5), the controller won't dose Acid and will display CHECK in the pH box. If the system is displaying CHECK, you will need to take a sample of your pool water to your local pool shop and get it tested and add the amount of Acid or Buffer required to get the pH level back to where it needs to be (7.2 – 7.8).

If the system is displaying ---, it indicates that there may be a fault with the probe itself or indicates an invalid reading.

2. The ORP reading is outside of the systems reading range of 300mV to 800mV. If the reading is lower than 300mV (<300) or higher than 800mV (>800), the controller won't Chlorinate and will display CHECK in the ORP box. If the system is displaying CHECK, you will need to take a sample of your pool water to your local pool shop and get it tested and either;

- a. add the correct amount of Chlorine required to get the ORP level back to where it needs to be (about 650mV), or
- b. stop chlorinating the pool for a certain amount of time to allow the chlorine level to lower. If the Chlorine level is too high, a Chlorine Reducer chemical can be added to the pool to reduce the Chlorine level.

If the system is displaying ---, it indicates that there may be a fault with the probe itself or indicates an invalid reading.



## 4. ANCILLARY INSTRUCTIONS

### Maintenance Schedule

#### Fortnightly

- Check the level of the Acid bottle /tub to ensure that it won't run dry. Use a 2:1 water acid mix ratio. **WARNING: Always add concentrated acid to water when diluting, NOT water to Acid.**
- Test pool Water Chemistry.

#### 3 Monthly

- Ensure that the Check valve is holding liquid in the feed tube.
- Check and ensure that the acid feeding tube is clean and clear where it injects acid into the piping. Clean or trim the tubing if required.

#### 6 Monthly

- Get your pool Water Chemistry tested at a pool store. Adjust calibration of the sensor readings if required. Use the pH and ORP Offsets to adjust (see page 8 of this manual).
- Check all tubes, fittings and connections to ensure no leaks.
- Check the squeeze tube in the Peristaltic pump to ensure that it isn't leaking, replace if doing so. Apply a silicon lubricant to the tube and gears if necessary
- Clean and re-calibrate the probes if necessary. Cleaning instructions are on Pg 16 of this manual.

#### Yearly

- Check the squeeze tube in the Peristaltic pump to ensure that it isn't leaking, replace if doing so. Apply a silicon lubricant to the tube and gears if necessary. Replacement Part No: 3223109.
  - It is recommended that the squeeze tube be replaced every 12 months for optimum performance.

**Regular checks and maintenance will ensure trouble free performance and longevity of the Oasis SmartChem system.**

Get in contact with your local pool technician if you need help with the maintenance of your pool and or your pool equipment and the **Oasis SmartChem** system.

### pH Probe

The cleanliness of the sensor and junction is critical for an accurate measurement. Drift (Offset) and a slow reading response are often due to an unclean sensor or junction. DO NOT use abrasive materials to clean the probe. The IH40 is supplied with a white cleaning tool. It can be used instead of the tissue/cotton detailed below. Simply put some of the cleaning agent in the tool and use this to clean the membrane.

- **To remove inorganic deposits and scale**
  - Soak membrane in dilute HCl for an hour. Wash well with water and condition in 20% KCl solution before use.
- **To remove solids and organics**
  - Wipe the membrane with cotton or tissue soaked in mild non-alkaline detergent. Wash with water and condition in 20% KCl before use.
- **To remove strongly adsorbed and chemically bonded impurities**
  - Use a non-abrasive cleaner such as Jif™ undiluted on a soft cloth. Clean the pH membrane, rinse with water and condition in 20% KCl before use. In the case of protein contamination use 5% Pepsin in 0.1M HCl solution.

**HINT:** Calibrate the pH probe regularly. The frequency of calibration will depend on the level of accuracy desired. When calibrating, always use fresh buffer solution.

### ORP Probe

The cleanliness of the sensor and junction is critical for an accurate measurement. Drift (Offset) and a slow reading response are often due to an unclean sensor or junction. DO NOT use abrasive materials to clean the probe.

- **To remove inorganic deposits and scale:**
  - Soak sensor tip in dilute HCl for an hour. Wash well with water and condition in 20% KCl before use.
- **To remove solids and organics:**
  - Wipe the sensor tip with cotton or tissue soaked in mild non-alkaline detergent. Wash well with water and condition in 20% KCl before use.
- **To remove plated metals from ORP tips.**
  - Soak the tip in approximately 0.1M nitric acid for 15-20 minutes, followed by conditioning in 20% KCl.

**HINT:** Clean the electrode periodically. Unclean sensor tips are a very common source of error in ORP measurements.

## Replacing The Squeeze Tube

The first thing that you will need to do is open the App Menu and go into Chemical Setup. When you are in the Setup menu you will need to turn the Acid Dosing button to the Off position. This will stop the peristaltic pump from operating while you are replacing the Squeeze Tube.

Remove the tubing from the Intake and Output sides of the Peristaltic Pump.

To replace the squeeze tube of the Peristaltic pump, you will need to remove the head cap (green cover).

To remove, put your thumb under the lip at the bottom of the head, gently but firmly lift the cover.

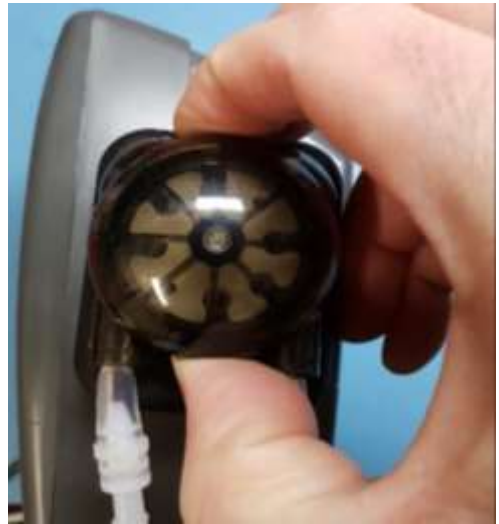

The head cover will come off to expose the squeeze tube and the head.



The pump head can be pulled out (the squeeze tube will come with it) and a new squeeze tube can be wrapped around the head, and the head re-installed onto the motor shaft.

Ensure that you apply some appropriate, silicon-based lubricant onto the pump head and the squeeze tube.

Once the lubricant has been applied, the head cover can be re-installed. Ensure that the squeeze tube is seated properly.

Re-attach the tubing running from the bottle and running to the dosing manifold, making sure that both are clean and clear.

Once re-installed, ensure that you go back into the Chemical Setup menu in the App and turn the Acid Dosing button back to the On position and prime the dosing pump as per page 9 of this manual.





## 5. SYSTEM TROUBLESHOOTING



If you suspect for any reason your **Oasis SmartChem** system is not performing or running as it should be, here are some handy troubleshooting tips that may assist you.

The first thing to do is test your Water Chemistry with either a good quality test kit or take a sample of your pool water to your local pool store and have it tested.

Fault Indication	Remedy
pH is too Low	Excessive fresh water added to the pool (through either rainfall or topping up the pool with fresh water) which dilutes the Total Acid level. Adjust pH level as directed by your local pool shop.
	pH probe not reading correctly Clean and or Re-calibrate probe or adjust probe Offset (as per pg 8). pH Set Point is set to Low Adjust pH Set Point to appropriate level (7.2 - 7.8).
pH is too High	Filter run time/s aren't sufficiently long enough to ensure appropriate dosing rates Lengthen filter run time/s.
	Acid dosing bottle/tub is empty Re-fill bottle/tub with diluted acid at the appropriate ratio. CAUTION Always add acid to water when diluting, NOT water to acid.
	Dosing acid is over diluted - Re-dilute the acid at a ratio closer to 1 part acid to 2 parts water.
	pH probe not reading correctly Clean and or Re-calibrate probe or adjust probe Offset (as per pg 8). pH Set Point is set to High Adjust pH Set Point to appropriate level (7.2 - 7.8).
	Manual Overdosing of Chlorine (Shock Treatment) Maintain pH Set Point. It may take a period of days to weeks or the pH reading to drop return to normal levels. This depends on how large the Overdose (shock treatment) was. The <b>Oasis SmartChem</b> will continue to operate normally during this time.
	Dosing pump is not operating as it should - Check the following;
	Acid dosing pump is working Press the Prime button (as per pg 9) and confirm pump works.
	Check for a blockage at the Injection point Remove the injection tubing from the Injection Point, check/ensure the tubing is clean and clear. If not, clean/trim the end of the tubing and re-attach.
	Air leakage Check all connections to ensure they are tight and no air leaks are occurring. If any connections look suspect, trim the tubing and re-attach.
	Acid Dosing container is air tight If the dosing container is air tight, it won't allow any liquid to be pumped from the container. Ensure appropriate container lid is fitted and the connection points are clean and clear.
Dosing pump squeeze tube is leaking Squeeze tube needs replacing. Check to ensure that no water is returning to the Dosing container. Replace the Check valve (non-return valve) if there is water returning to the dosing container. If there is no Check Valve installed, please install one.	

	<p>Filter run time/s aren't sufficiently long enough or Chlorinator output isn't high enough          Lengthen filter run time/s or increase Chlorinator output. Make sure Chlorinator is working.</p>
	<p>Filter requires a back wash          Back wash filter.</p>
	<p>Stabiliser (Sun Block) level is too Low (Outdoor Pools)          Adjust level of Stabiliser to appropriate level</p>
<p>Chlorine is too Low</p>	<p><b>Note: The need to run Stabiliser in an outdoor pool may be reduced if your Chlorinator is sufficiently sized to produce enough chlorine to negate the use of Stabiliser, ie the bigger the chlorinator the lower the stabiliser level needs to be.</b></p> <p>pH level is too high – Adjust pH level to correct level (7.2 – 7.8).          ORP probe not reading correctly - Clean and or Re-calibrate probe or adjust probe Offset (as per pg 8).          ORP Set Point is set to Low - Adjust ORP Set Point to appropriate level, 700mV.</p>
<p>Chlorine is too high</p>	<p>pH level is too high          Adjust pH level to correct level (7.2 – 7.8).          Total Dissolved Solid levels are too high          The only way to decrease the Total Dissolved Solids (&lt;1500ppm) level of your pool is to introduce fresh water to dilute the pool water. Give your Filter a really long backwash to drop the level of your pool (by the amount recommended by your pool shop) and re-fill with fresh water.          Stabiliser (Sun Block) level is too High (Outdoor Pools)          Adjust level of Stabiliser to appropriate level (30-50mg/L). As per above.  <b>Note: The need to run Stabiliser in an outdoor pool may be reduced if your Chlorinator is sufficiently sized to produce enough chlorine to negate the use of Stabiliser, ie the bigger the chlorinator the lower the stabiliser level needs to be.</b>          ORP probe not reading correctly - Clean and or Re-calibrate probe or adjust probe Offset (as per pg8).          ORP Set Point is set to High - Adjust ORP Set Point to appropriate level, 700mV.          Manual Overdosing of Chlorine (Shock Treatment) - Maintain ORP Set Point. It may take a period of days to weeks or the ORP reading to drop back to normal levels. This depends on how large the Overdose (shock treatment) was. The <b>Oasis SmartChem</b> will not continue adding chlorine during this time period.</p>

**DISCLAIMER:** Information in this guide is intended to provide general information on a particular subject(s) in good faith and is not an exhaustive treatment of such subject(s). Its use is beyond the control of the author, contributor, publishers, licenced professionals and under no circumstances should the guide be used as a substitute for such professionals. No representations or warranties are made that the content, advice and recommendations in this guide are current, free from errors or omissions, or appropriate for the user's circumstances or abilities. No liability or responsibility is accepted persons or **OASIS AQUATICS Pty Ltd** appointed agents. **OASIS AQUATICS Pty Ltd** reserves the right to refuse warranty if any damage caused to the chlorinator or auxiliary pool equipment that is not a result of a manufacturer's defect.



## 6. FURTHER INFORMATION

- Should power be interrupted for any reason, the controller will resume normal operation when power is restored.
- Degree of protection against moisture: IP33.
- Store pool chemicals safely, at least 1.8 metres away from all pool equipment.
- MAX combined rated input load for the JVA socket is 24Vac at 1.2Amps.
- The pool size and the proximity to the pH & ORP Set Points determines how long (in seconds) the pump will actually dose for.
- The length of time between one dose of acid and the next is approximately 30 minutes. This gives the pool water a chance to mix properly and create a true reading before the next dose is administered. This helps to ensure that overdosing doesn't occur.
- The pH dosing pump will inject the acid into a spa for either 2 or 4 seconds per dose. The amount of dosing time will depend on the size of the spa.
- The pH dosing pump will inject acid into a pool at a time range of between 4 and 50 seconds per dose. The amount of dosing time will depend on the size of the pool. The larger the pool, the longer the dosing time.
- On the Home screen of the Oasis Smart App, pH readings will only be displayed of a value between 5.5 to 8.5. If the reading is outside of this range, the App will display either, <5.5 (check), >8.5 (check), or —(check).
- The Smartchem will be able to read a pH range of 0 (strongly acidic) to 14 (strongly alkaline) but any reading outside of the 5.5 to 8.5 range will only be displayed in the Chemical Setup option of the menu.
- ORP readings on the home screen of the Oasis Smart App will only be displayed where the value is between 300 to 800. If the reading is outside of this range, the App will display either, <300 (check), >800 (check), or —(check).
- The Smartchem will be able to read a ORP range of 0 (little to no Chlorine) to 1000 (possibly over chlorinated) but any reading outside of the 300 to 800 range will only be displayed in the Chemical Setup option of the menu.
- In the Chemical Balance window on the home screen of the Oasis Smart App, the status text will display whether the pH or the ORP readings are 'Low', 'High', or 'Normal' in comparison to the Set Points for both.
- If for either the pH or ORP levels, '---' is displayed, this is indicating a missing/faulty probe or an invalid reading. A water sample test is advised at this point.
- The Sensor & Injection Manifolds suit 50mm pipe, 4 reducing bushes will be required if you are installing the manifolds into 40mm pipe
- If the pool system is to shut down for a lengthy period of time (eg; repairs to the pool surface), it is recommended that the pH & ORP probes be removed from the Injection Manifold and be stored appropriately. This involves putting storage fluid (20% KCl) into the small bottles the probes came in, putting the probes into the fluid, and screwing the nut to the top of the bottle.
  - If you don't remove the probes and put the pH & ORP probes into the storage solution, the probes may be damaged and they won't be covered under warranty.

- If you are storing liquid chemicals (Chlorine & Acid) in the same location, it is advisable to keep these chemicals stored in visually different containers, whether by colour and/or size, ie Liquid Chlorine in a 15L blue container, and Liquid Acid in a black container or clear 5L container.
- If concentrated pool acid and chlorine are mixed together outside of the pool water, they will produce a poisonous gas.
- The **Oasis SmartChem** is not designed to bring the Pool/Spa system into balance; it is designed to maintain a balanced system. If you need to balance your pool system before installing the Smartchem, add the pool chemicals slowly and carefully allowing an appropriate interval of time for the added chemicals to properly mix throughout the pool system. Continue testing and adding chemicals until the pool system becomes balanced.
  - If you add large quantities of chemicals quickly, you may overdose the pool water. It may then take weeks for the pool water to remove these chemicals through natural dispensation and return to a balanced state.
- Make sure that the squeeze tube in the peristaltic pump is lubricated every 6 months and for optimum performance replaced every 12 months. When lubricating the tube, only use an appropriate silicone based lubricant. DON'T use a petroleum based lubricant as damage may occur to the tube which may lead to the tube leaking and premature replacement of the tube which won't be covered under warranty.
- If you are doing any work on the **Oasis SmartChem** peristaltic pump , tubing, or probes, be sure to deactivate Acid Dosing (see Chemical Setup page 9 of this manual).

## 7. WARRANTY

**THIS EQUIPMENT HAS BEEN MANUFACTURED AND TESTED TO THE HIGHEST STANDARD AND ACCORDINGLY CARRIES THE FOLLOWING WARRANTY.**

Your **Oasis SmartChem** controller is covered by a limited **three-year (3)** warranty against component failure or faulty workmanship from the date of installation.

Valves, actuators, sensors, ORP & pH Probes have a 12 month warranty

This is a back to base warranty excluding on-site labour or travel costs to or from installation site. Replacement of routine maintenance items are not covered under warranty.

Defective equipment must be returned to the manufacturer or dealer as soon as the purchaser becomes aware of the defect and all transport must be prepaid. Neither the manufacturer nor the dealer shall be responsible for any goods damaged in transit.

Adverse operating conditions beyond the control of the manufacturer such as improper voltage or water equipment will render this warranty null and void.

Any liability of the manufacturer pursuant to the Trade Practices Act 1974, as amended for a breach of a condition or warranty shall be limited to replacing or acquiring the equipment (or part thereof) where the same has been supplied.

The maximum liability incurred by the manufacturer shall not in any case exceed the contract price for the equipment or the product parts or components thereof claimed to be defective. Further, the manufacturer shall not be liable for any loss, damage or delay directly or indirectly caused by any malfunction of or defect of or failure of the equipment other than as expressly provided in this warranty.

The manufacturer will not be held liable for damage caused by, but not limited to, corrosion, scaling or stress.

**The Warranty is void under the following circumstances:**

- Installation is carried out incorrectly by any person other than a person authorised by us to do so.
- Insect infestation or penetration by dust, sand or other foreign particles
- Damage beyond our control
- Equipment that has been misused, neglected, damaged, repaired without authorisation or altered in any way.
- This warranty is not transferable under any circumstance.
- Keep your original purchase invoice and serial number in a safe place.



**If the power cord is damaged, do not use the controller.**

**Return the unit to the supplier for repair.**

## 8. TECHNICAL SUPPORT

For all warranty enquiries please contact your local distributor or contact **Sunlover Heating** directly and we will either direct you to your nearest authorised repairer or assist you.

### OASIS AQUATICS

Ph: 1800 815 913

Website: [oasisaquatics.com.au](http://oasisaquatics.com.au)

Email: [info@oasisaquatics.com.au](mailto:info@oasisaquatics.com.au)

### DISCLAIMER

Information in this guide is intended to provide general information on a particular subject(s) in good faith and is not an exhaustive treatment of such subject(s). Its use is beyond the control of the author, contributor, publishers and distributors and should not be relied upon without consulting your local Professional for comprehensive advice.

This guide includes subject(s) that should only be performed by or under the direction and advice of your local Professional and under no circumstances should the guide be used as a substitute for such professionals.

No representations or warranties are made that the content, advice and recommendations in this guide are current, free from errors or omissions, or appropriate for the user's circumstances or abilities. No liability or responsibility is accepted for any loss suffered as a result of any user's reliance on such content.







A part of the  Group

**Victoria**

6-8 Austral Place  
Hallam VIC 3803  
Australia  
T: 03 9887 2131

**New South Wales**

Unit 2, 10 Boden Road  
Seven Hills NSW 2147  
Australia  
T: 02 9838 0000

**Queensland**

11 Andy Court  
Upper Coomera QLD 4209  
Australia  
T: 07 5679 6821

**[oasisaquatics.com.au](http://oasisaquatics.com.au)**  
**[info@oasisaquatics.com.au](mailto:info@oasisaquatics.com.au)**